

# Sampson Mills

*Window Treatments & Spatial Dividers*

GEMINI | SHUTTLE | COLUMN

**F L A T  
P A N E L**



*Where your creativity can flourish with our ingenuity.*

## **THE COLUMN**

Stationary solution for spatial dividing and acoustical panels. Also suitable for areas with air flow, such as next to AC vents or doorways. Bottom supports recommended for air flow applications.

Compatible with tracks SF90 and SF120.

GEMINI

## **GEMINI**

Double tracks offer tight stacking window treatment or room dividing solutions for better views and more open spaces.

Compatible with PF121R, PF121 and PF120.

THE  
COLUMN

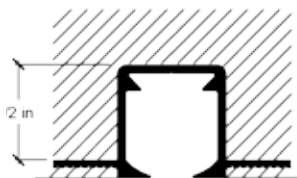

## **PF121R - Recessed Mount**

Simply drill through the track or use a nail gun on the wings when mudding track in.

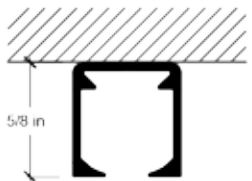

## **PF121 - Surface Mount**

Simply drill through the track. No clamps required for install.

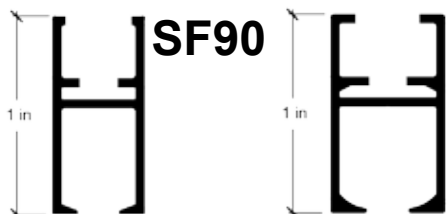

## **SF120/ PF120 - Suspension/ Wall Mount**

System can be mounted with adjustable suspension rods and tension cable to get around uneven ceilings or duct work.

SF90 and SF120 Stationary Panel Track.

PF120 for Curtain Track and Cubicle applications.

THE SHUTTLE

## THE SHUTTLE

Acoustical sliding flat panels and room dividers.

Compatible with:

**Recessed Track:** PF121

**Suspension/ Wall Tracks:** SF120, PF123, PF125

**Ceiling Tracks:** PF120, PF121, PF122, PF123, PF123, PF124, PF125

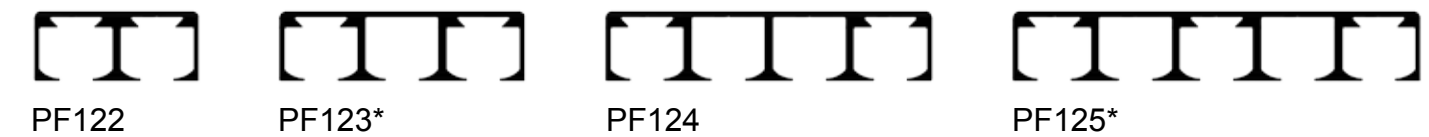

Tracks above not to scale

\*These Tracks are compatible with Suspension Connector SSB3

## SSB3

Flat Panel 3/5 Channel Suspension Connector

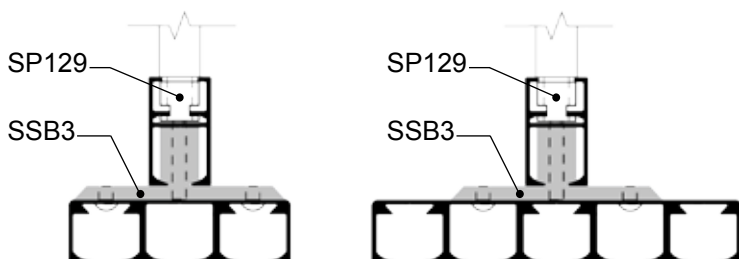

## LOCKE

Helps to reduce or remove tension. Recommended for soft and stretchy fabrics. Suitable up to 60lbs of load.

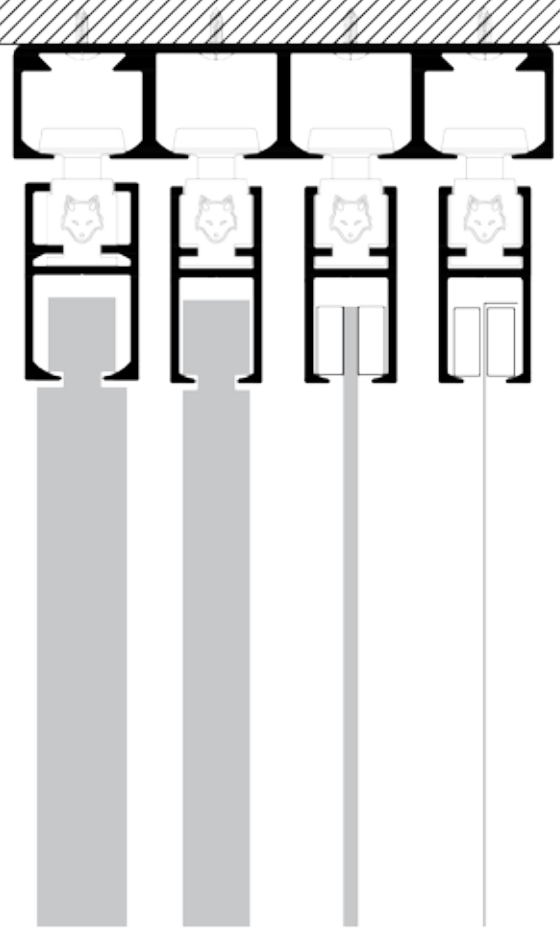
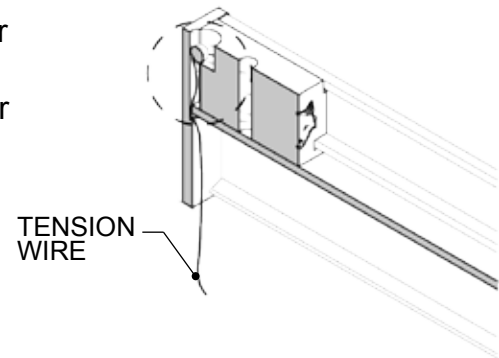

10mm-  
12mm

8mm-  
9mm

2mm-  
5mm

Fabric  
<1mm

3/8" -  
1/2"

5/16" -  
3/8"

1/16" -  
3/16"

< 3/64"

Carriers PFB120 (12mm) and PFB90 (9mm) shown.

## Development Program

*Please call or email us if you would like to utilize our Development Program for either private label, consulting services, or a request for product development.*

*Where your  
creativity can  
flourish with  
our ingenuity.*

### **Sampson Mills Ltd.**

Showroom:  
D&D Building  
979 3rd Ave, Suite 1540  
New York NY 10022

Assembly:  
810 East 141st Street, 3rd Flr.  
Bronx, NY, 10454

T (718) 412-9040  
F (718) 412-9039  
[www.sampsonmills.com](http://www.sampsonmills.com)

